

Varenummer: 230100044311
 Beskrivelse: E+G Håndsving
 MT.100 AS-12x12-SI

Mål

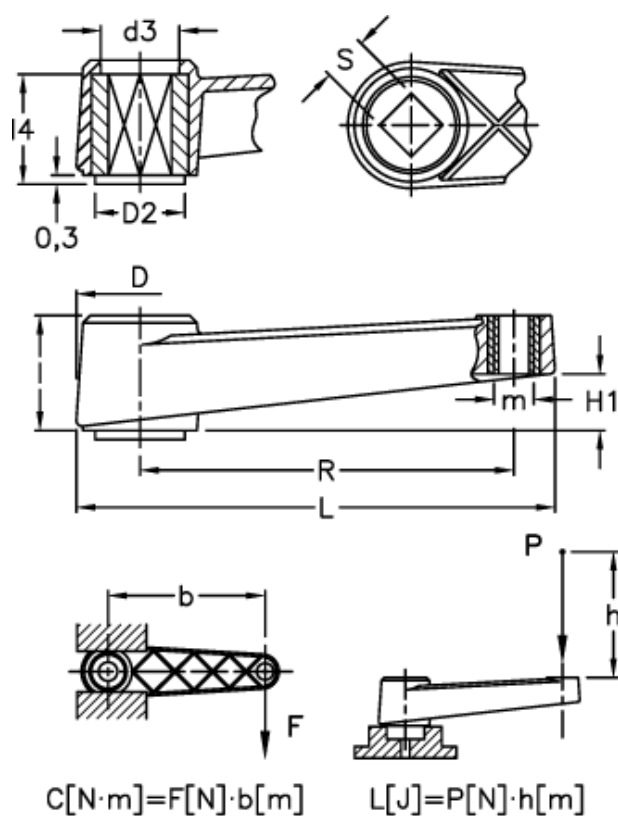

C (N*m)	= 200	l4	= 27
D	= 34	m	= M8
d2	= 25	R	= 100
d3	= 21	S H9	= 12x12
H1	= 15		
l	= 30		
L	= 128		
L(J)	= 27		